

Article number: 201463B25402SW

Description: E+G  
Flanged Connector GN 146.3-B25-40-2-SW

## Measures

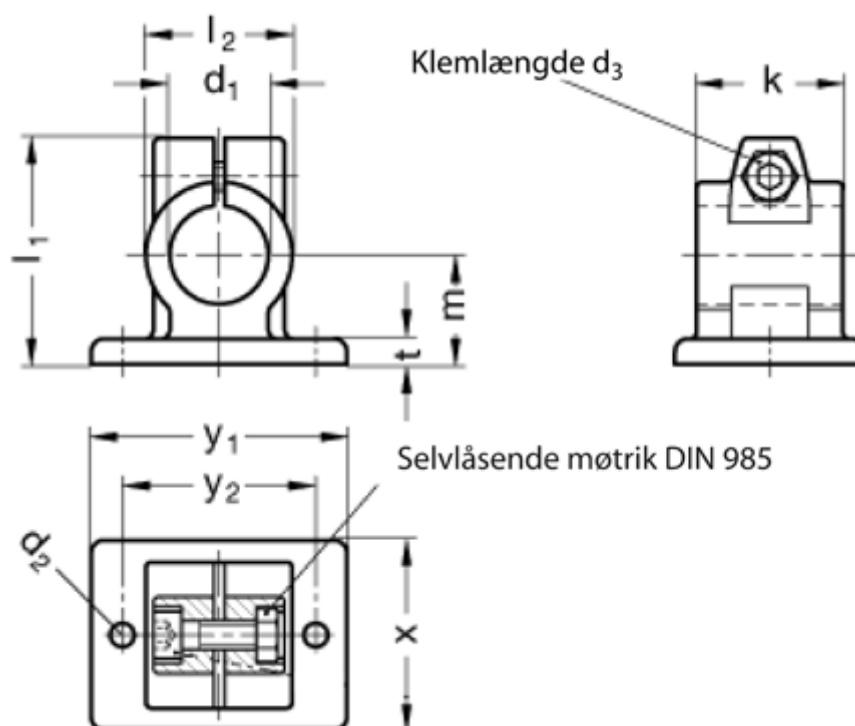

Adjustable clamp lever = GN 911-M 8-32 have to be ordred separately

d1 = B25  
d2 = 6.5  
d3 = M 8  
k = 40  
l1 = 62  
l2 = 40  
m = 30

t = 7  
x = 52  
y1 = 70  
y2 = 53